

MODEL SPECIFIC OPERATIONAL MANUAL



The XR represents the photonic and technological excellence at a cost hard to believe. It is our 30th-anniversary gift to the industry, with no corners cut.

ATOM **XR**

TABLE OF CONTENTS

1.	Introduction	3
2.	General Information	4
	2.1 What is a laser and how does it work?	6
	2.2 Laser Safety first!	7
	2.3 Installation of the System	9
	2.4 Control System	10
	2.5 Scanning System	11
	2.6 Connection Diagram	13
	2.7 Multiple System Interlock	14
	2.8 Switching ON sequence and User Interlock	15
	2.9 Maintenance	17
	2.10 Disposal of the Equipment	19
3.	Item Checklist	20
4.	Optional Accessories	21
5.	System Overview	22
	5.1 Front View	23
	5.2 Rear View	24
6.	Telemetry	27
7.	Beam Alignment Principle	28
	7.1 Beam Alignment with Motorised Dichroic Filters	31
8.	Colour Balance Display Mode	32
9.	Technical Specifications	36
	9.1 Technical Specifications [Atom XR 18 W]	37
	9.2 Technical Specifications [Atom XR 30 W]	38
	9.3 Technical Specifications [Atom XR 60 W]	39
10.	Troubleshooting	40
11.	Safety Features	45
12.	Contact Information	46
13.	Dimension Details	47

1 — INTRODUCTION

Thank you for purchasing this KVANT product.

To ensure proper operation, please read this manual carefully before using the product.

After reading it, keep it in a safe place for future reference.

GENERAL INFORMATION

2

The following chapters explain important information about lasers in general, basic laser safety and some tips about how to use this device correctly.

Please spend some time reading these information as some of them are critical for safe and efficient operation of this laser display system.



This laser entertainment system is rated as a **Class 4 laser product** and manufactured in accordance to **EN 60825-1:2014**. Avoid eye or skin exposure to direct or scattered radiation. Wear protective goggles of suitable optical density if necessary.

CAUTION

Please note that some other optical devices such as cameras, camcorders, video projector etc. can be damaged if exposed to excessive laser radiation.

HANDLING PRECAUTIONS

This laser system is a precision device that contains some sensitive opto-electronics components. DO NOT drop it or subject it to physical shock.

This laser system is not waterproof or dust-proof. Make sure to use an appropriate cover or enclosure if it is used in the rain, snow or similar severe environment conditions.

Do not leave the laser system in excessive heat such as in a car whilst in direct sunlight. High temperatures could cause some serious damage to the system.

The laser system contains precision electronic circuitry. Never attempt to disassemble the laser yourself.

If the laser is suddenly brought in from the cold into a warm room, condensation may form on the laser and internal parts.

If condensation forms on the laser body, do not use the laser as this may damage the laser system. If there is condensation, wait until it has evaporated before using it.

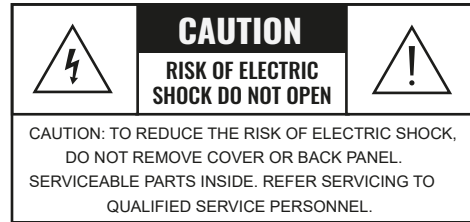

user manual



Max current at 100%: 3A
 Max current at 250%: 5A

WHAT IS A LASER AND HOW DOES IT WORK?

2.1

WHAT IS A LASER?

The laser is a device that creates continuous visible light energy waves (streams of photons that are referred to as “laser radiation”) with the same amplitude and phase that are flowing in the same direction; meaning they are coherent – they stick together and form a laser beam.

The width of a single wave is measured in nano-meters and defines the colour and visibility of the laser beam. The visible spectrum of the human eye is roughly between 400nm and 700nm, going from violet to a dark red colour.

A human eye is most sensitive to a green light of around 555nm, meaning that a 1W of green laser will always appear more visible than 1W of any other colour laser. 1W of quality laser light is very powerful and although it doesn't sound like much it can burn eye retinas, skin and clothes or even start a fire!

WHAT MAKES THE LASER VISIBLE IN MID-AIR?

Mainly it is the particles of dust in the air that the laser beam hits on its path, scattering the light. This dust or fog is called a “scattering medium”. That's why we “laserists” use haze or smoke machines to make lasers more visible. Too much of the haze or smoke will greatly attenuate the visibility, but the right amount will make all the difference between no show and a great show.

When outdoors, lasers mainly reflect off dust and mist in the air but due to unpredictable wind conditions we can never make sure the hazers or smoke machines will be effective enough. And that's why we use high power lasers for outdoor shows – to substitute for the lack of dust, haze and smoke.

HOW FAR DOES IT TRAVEL?

Technically, the laser light will travel forever until it strikes a surface and is absorbed.

A better question is – how far will the light travel and still be useful? Depending on the power output of the system and weather conditions, the laser can be visible for miles – that is why we need to be cautious about aircrafts when performing outdoor shows. And if you get a system that is powerful enough then yes, it can reach the Moon.

COLOURS

Standard full colour analogue lasers use three primary colours: Red, Green and Blue. By mixing those together you can pretty much get any secondary colour:

Red + Blue = Magenta

Red + Green = Yellow

Green + Blue = Cyan

Red + Green + Blue = White

Of course the number and precision of the colours is determined by the modulation, stability and linearity of the system. If the system is not stable enough, it will produce different colours every time it is used, making it virtually impossible to match the colours of two systems at any one time. This is very often the case with systems from far east manufacturers and with re-branded lasers that are being presented as European makes.

SCANNING SYSTEM

A scanning system is essentially two tiny mirrors, each moving on X or Y axis. By working together they can “scan” the laser beam over a wide angle in front of the projector. The scanning system can not only direct the laser beam to specific, static locations, but it can also create shapes by rapidly moving the laser beam over a path. Once a shape is scanned more than 20 times per second, it appears static to the human eye. So any shape drawn by a laser is actually produced by one single laser beam being moved by these mirrors very quickly. Every scanning system has a mechanical limit of how fast it can move its mirrors and therefore how many points it can display at any one second and that is usually represented in Points Per Second at a certain scanning angle, i.e. 8 degrees.

LASER SAFETY FIRST!

2.2



Before proceeding any further, please read the following safety page very carefully. It could help you avoid dangerous and hazardous situations which could lead to serious injury or property damage.

The laser projector should be operated by an adult person who passed their training as a Laser Display Operator of Class 4 laser devices. The operator should be aware of and follow all the regulations, requirements, and laws regarding a country where operating the Class 4 laser system.

The manufacturer holds no responsibility for injuries or damages caused by the use of this laser display equipment.



Any laser system classified as a Class 4 laser must be used with caution. If you are an inexperienced laser operator, we strongly recommend that you attend a laser display safety course before you use this laser system in public areas.

There are various places in Europe where you can attend quality training and even a one day course will give you a good amount of valuable information to safely start with.

Unless you are very competent with the use of lasers and about the laser safety, make sure you at least follow these basic laser safety rules:

1. Never look directly into a laser beam
2. Never look directly into laser aperture if the laser system is switched on.
3. Be aware that lasers can burn the eye retina, skin or cause fires if not used correctly.
4. Audience Scanning is a technique that involves projecting laser effects directly into an audience. Never perform Audience Scanning unless you: a) are trained to do Audience Scanning; b) use a projector that has the proper safety systems built in (such as PASS); and c) have verified that the projected light levels do not exceed the applicable MPE for the jurisdiction. Otherwise, always project with the laser above audience head level – at least 3m above floor level.
5. When projecting the laser outdoors, avoid pointing the laser at aircrafts, buses, trains, etc. Never leave the laser system unattended when it's switched on.
6. Always check for reflective surfaces within the laser range – these can be very dangerous (i.e. mirror behind the bar in a club could bounce the beam into bar attendant's eye).
7. Never hesitate to use the Emergency STOP if you think there's a fault within the laser system or a potential danger to a person/object caused by the laser performance.



The manufacturer is not liable for damages or a injury caused by improper installation of the system. The installation should be carried by a qualified installer who should follow the Laser Safety Regulations of respective country.

Please follow these rules during the installation:

1. Do not connect the device to power supply during the installation. Only connect the device to power after the installation and mounting have been completed.
2. Mount the system only to mounting point that is strong, secure and away from places where nonauthorised person could get an access to.
3. Always make sure the system is properly tightened down, and that it cannot get loose and move as a result of sound vibrations, cables pulled on, or similar external disturbances.
4. Always attach a safety chain or cable between the projector and its structure (such as truss).
5. Ensure that all the cables have enough length just incase they get caught.
6. Ensure that the system is placed at least 20cm away from walls or any other objects including drapes etc.
7. Ensure that the system is placed well away from any heat sources including spotlights, moving heads, radiators, etc. Make sure there is a sufficient air-flow around the laser system.
8. It is essential that the fan openings are never covered during the laser operation.
9. Always follow the Laser Safety Regulations of respective country where the laser is being used.

The overall performance of any KVANT laser system is also dependent on the control system that you use for operating the laser as well as the correct device configuration in the laser control software.

Please make sure all the laser settings in your control system are set correctly before you start using your Kvant laser display system.

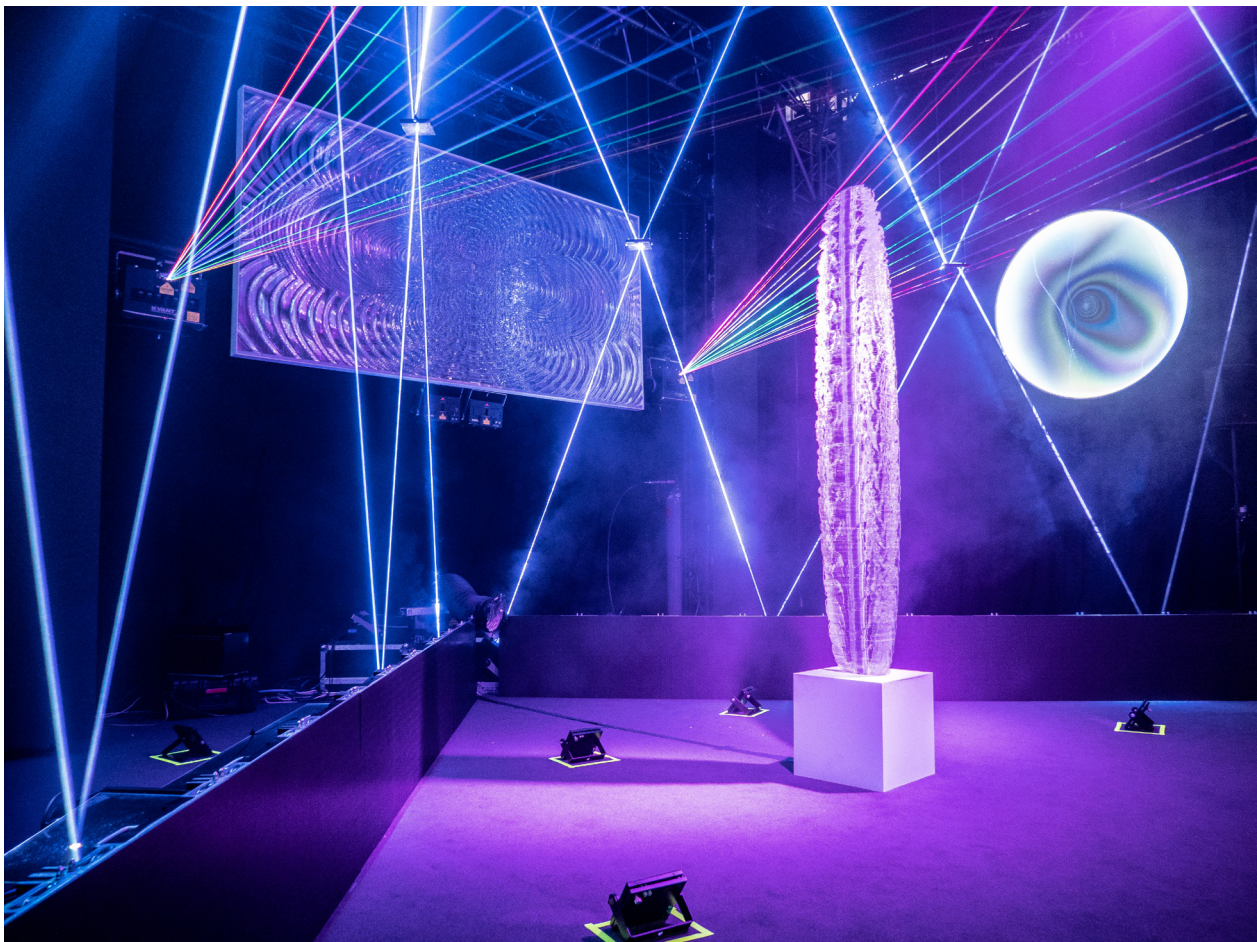

The product warranty does not cover the damages to the scanning system caused by improper use of the scanning system or by incorrect programming. Therefore it is essential to understand how the scanning works and where are the limits of it.

In this manual we will explain only the basics of it but it is the responsibility of every user to educate themselves so they can avoid damage being caused to the scanning system and costly repairs.

A laser beam comes from a laser module and hits the two moving mirrors of the scanning system. These mirrors are mounted on the scanner shafts and are moved by the scanner rotors, one on X and one on Y axis.

An effect such as tunnel (circle) is displayed by a repetitive mechanical movement of the scanners. For each scanning system and effect, there's a maximal scan-rate that is defined by mechanical load, scanner mirror size and weight, complexity of displayed picture and size of the projection (an angle under the laser beam is being projected).

A different scanning systems have different scan-rate limits. It is essential to operate the scanning system at scan-rates within its maximal limit at all times to prevent it from overload damage.

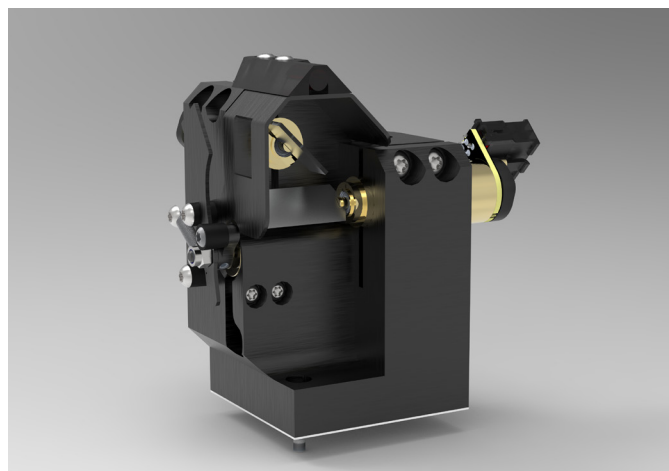
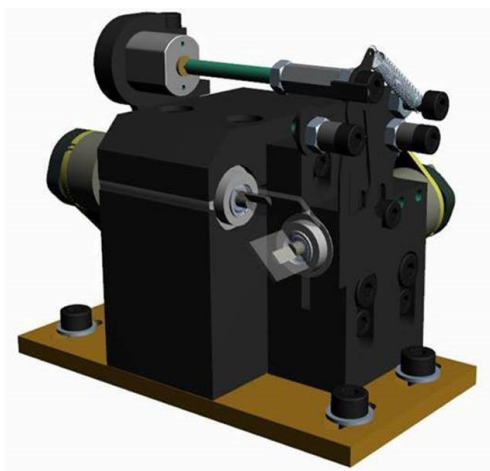

HOW TO ESTABLISH CORRECT SCAN-RATE AND MAXIMAL NUMBER OF POINTS IN AN EFFECT

Each effect (picture) contains a different number of graphical points which defines the actual shape of the effect. The more points an effect contains, the lower the maximum scan rate will be in relation to the scanning angle.

As an example we'll work with the star effect shown below and with the parameters of quality scanning system:

Let's say the star effect is made of 300 graphical points (including non-visible blanking points) and we know that the maximal scan-rate of our scanning system is "35K". (The term "35K" refers to a metric that is achieved when the original ILDA test pattern is projected at 8 degrees, and all of its visual qualities are maintained. Note that all other patterns may be scanned much wider, and in some cases even faster, but the term "35K" only refers to a single test pattern, and single test condition). We also know that we display the star 35 times per second which is a default frame rate of the control software we are using.

So we need to display 300 points 35 times per second = 10.500 pps. This means that we could display 3 of these stars beside each other within one single laser effect and that it would be quite close to the scanner limit ($3 \times 10.500 = 31.500$ pps). Given that the scanners noted above are "35K" scanners, this seems easily achievable. However, the projection of 3 separate stars necessitates a wider scan angle, and – in general, the scan speed must be reduced as the projection angle is increased. Thus, it may be necessary to either lower the number of points within the effect or drop down the scan-rate in the control software (FPS) to a safe level – which may result in flicker.

In the following pictures you see the same star effect scanned at different scan rates at full scanning angle (60 degrees).

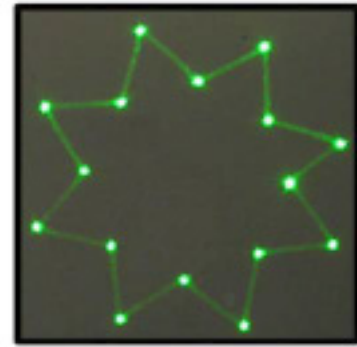

picture 1

PICTURE 1: the scan rate and/or number of points is too low. The corner points are more visible than the lines between them and the whole effect flickers. The scan-rate and/or number of points needs to be increased.

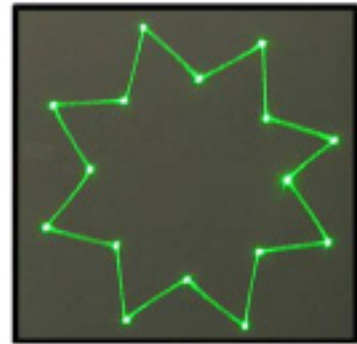

picture 2

PICTURE 2: the scan-rate and/or number of points is about right. The whole effect has more or less the same intensity and does not flicker.



picture 3

PICTURE 3: further increasing of the scan-rate and/or number of points results in the effect starting to distort, firstly around corners only. This indicates that you are exceeding the maximal scan rate of the scanning system! If you operate the scanning system at scan-rates higher than the maximum scan-rate of the scanning system the scanners will get damaged irreversibly due to overheated coils damaging rotor magnets.

CONNECTION DIAGRAM

2.6



Both E-STOP Remote safety key and laser system safety key must be inserted and switched to ON position in order to disable the interlock.



USA ONLY: Remote Interlock Bypass must be inserted in the E-STOP Remote as well in order to disable the interlock.

Please check that all the signal and power leads are correctly installed and that the safety keys are inserted in all necessary positions.

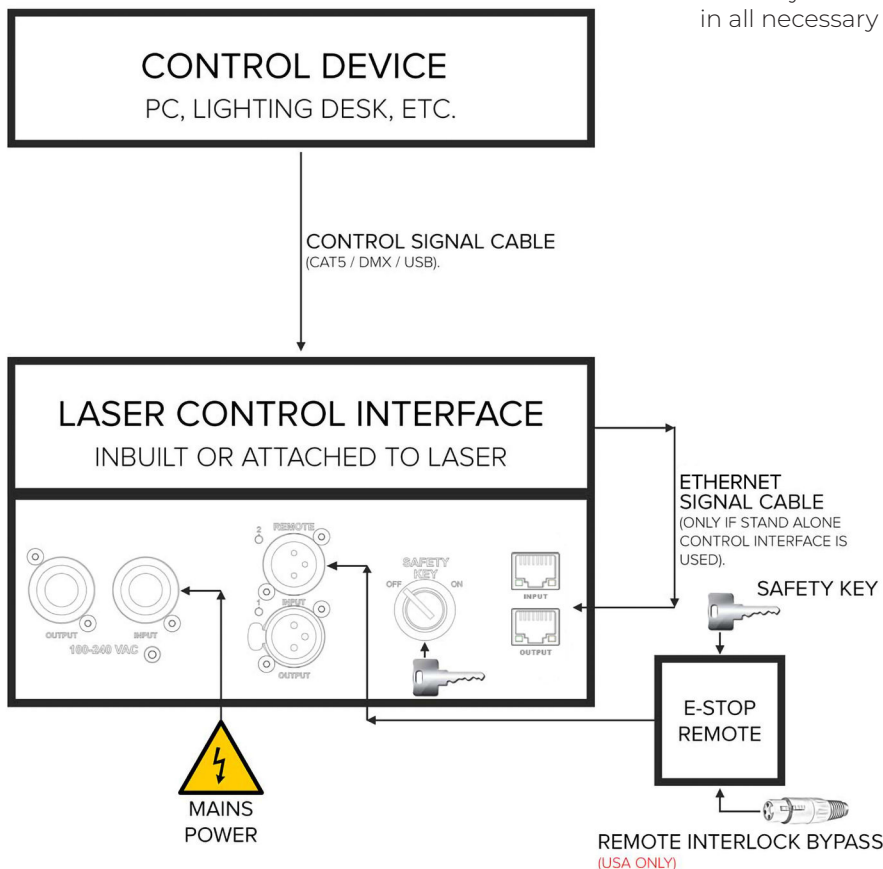

SWITCHING ON SEQUENCE AND USER INTERLOCK

2.8



Please make sure that all laser display safety requirements are fulfilled in accordance with laws of the country where this KVANT laser system is being used before switching the system ON.

1. Connect the system as showed on Connection Diagram.
2. Turn both E-STOP Remote and laser system safety keys to ON position.
3. Release the E-STOP button by pulling it upwards.
4. Open the aperture window by loosening the bolt at the bottom of the aperture, adjust the masking plate to desired position and tighten the bolt to secure it .
5. Press the START button on the E-STOP Remote.
6. After an Emission Delay Period the laser projector will be ready for use.

INTERLOCK ENABLED, LASER OUTPUT TERMINATED

The Interlock is latched enabled and the laser projector's beam output will be terminated if any of the following events happen:

1. Power loss lasting greater than 2 seconds.
2. Mushroom emergency switch depressed.
3. #2 Key Switch on E-STOP Remote turned to OFF position.
4. #1 Key Switch on laser projector turned to OFF position.
5. Any other interruption to line No.1 of the cable leading to the E-STOP Remote. This includes any user interlocks connected in series in the line No.1 of this cable. Refer to Connection Drawing to the side.

INTERLOCK CONNECTION DIAGRAM

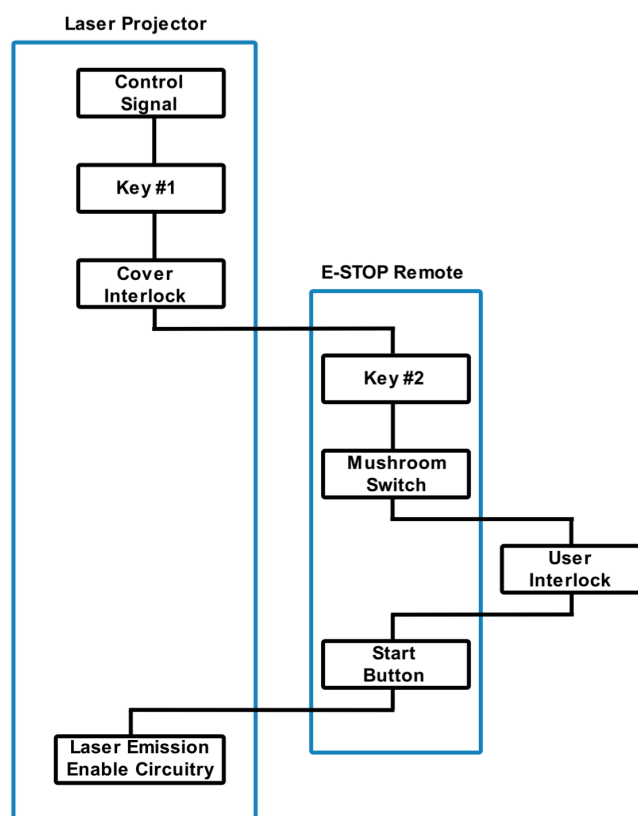

RESTARTING LASER AFTER INTERLOCK OR POWER FAILURE EVENT

After the event has been corrected the START button on the E-STOP Remote must be pressed by the operator to disable the Interlock and after an Emission Delay period the laser projector will be ready for use.

E-STOP CONNECTION DRAWING INCLUDING USER INTERLOCK OPTION

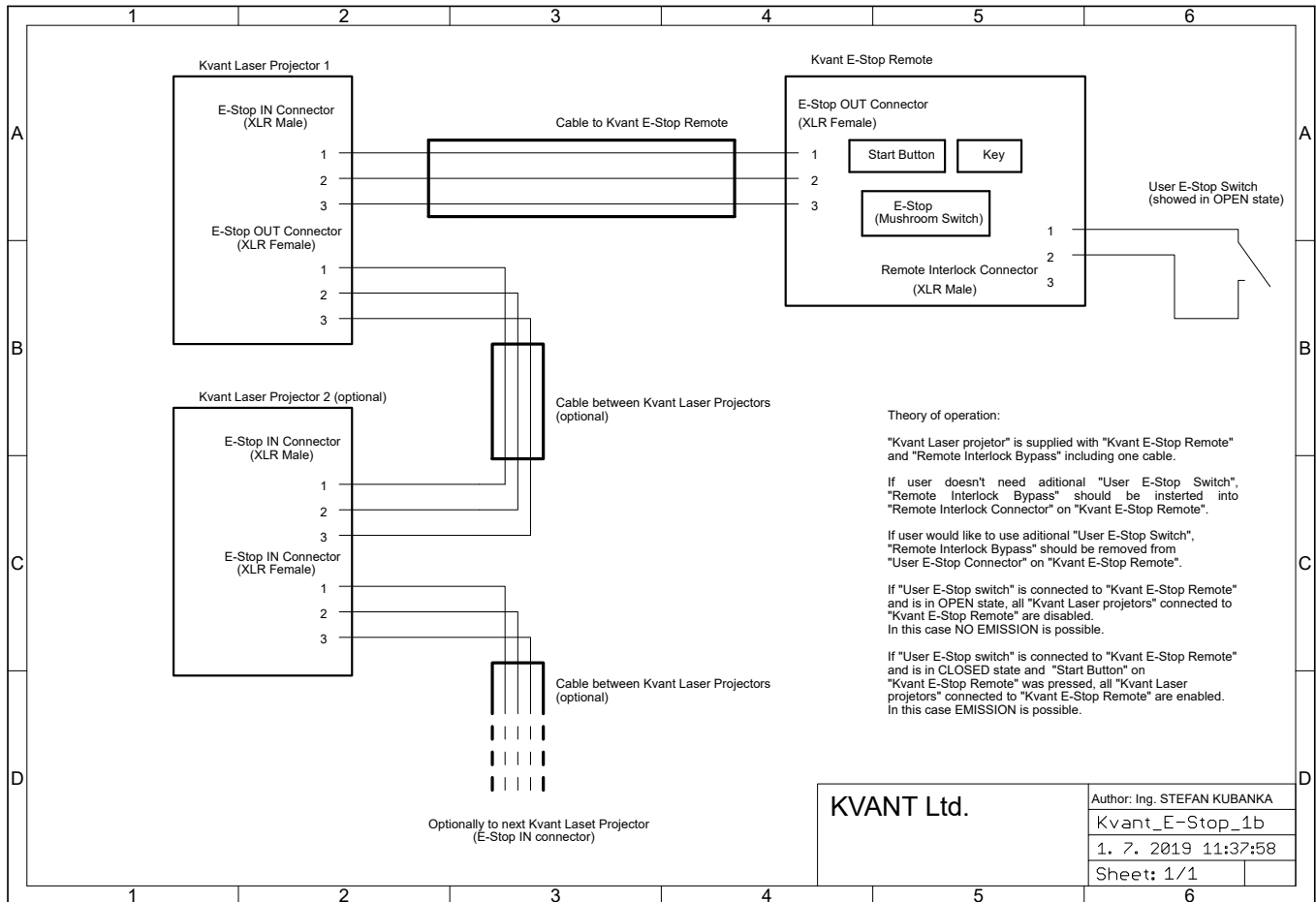

The E-STOP Remote is an integral part of the laser projector. It is there for the safety of the public as well as the operator. Modifying or using anything other than the E-STOP Remote provided, in the manner it was intended, may invalidate your laser projector's variance.

NO USER SERVICEABLE PARTS INSIDE

Please note that a laser light entering the aperture of your laser projector (reflected or from another laser) or wrongly reflected beams inside the projector can permanently damage the laser sources.

The manufacturer's warranty does not cover such damage.

APERTURE WINDOW

To clean the aperture output window use a soft cloth and medical grade isopropyl alcohol. If necessary, you can remove the aperture output window by loosening the 4 socket bolts and clean the inside of the window as well.

COOLING FANS

Use compressed air for cleaning the bottom part of the laser system. There are cooling fans located at the bottom of the heat sink and they are vital for correct operation of the laser system. Please always ensure that they are spinning freely.

You should perform this service every 2 months if the laser is used regularly or even more often if it is used in dusty conditions.

INTERNAL OPTICS

The cleaning of the internal optical components should be performed by an authorised technician only. Incorrect techniques or wrong choice of chemicals used for cleaning could cause serious damage to the laser system. Due to the fact that the optical compartment is split and sealed from the rest of the laser system it shouldn't be necessary to perform this procedure more often than once a year.

DRYING AGENT CARTRIDGE

Drying agent cartridge (silica gel desiccant) helps to prevent water condensation inside the optical compartment of the laser system, which is much needed in high temperatures and high humidity environments. The desiccant cartridge is installed on the inside of the optical compartment cover.



It is essential to regularly inspect the condition of the silica gel granules inside the cartridges. That can be done through the opening in the middle of the cartridge. If the colour of the granules inside the cartridge is green, instead of brown (brown is when they are dry), it means they are soaked, and they must be dried out. Inspect the cartridge every time you open the optical compartment, or at least once a month.

The drying out process is pretty simple:

1. Detach the cartridge from the cover and place it into the conventional oven - do not use microwave!!!
2. Heat the oven to 120°C (250°F) and leave the cartridge inside for about 3-4 hours, until all the moisture is released.
3. Insert the cartridge back into its place and close the optical compartment cover as soon as the cartridge cools down. That way, it will absorb the maximum amount of moisture from the inside of the optical section.

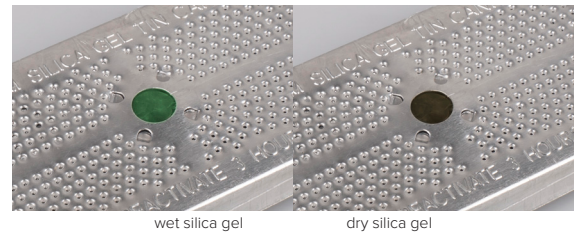

If the granules don't turn brown during this process, they must be replaced with new ones.

DISPOSAL OF THE EQUIPMENT

2.10











The equipment is made of components and materials such as metal, plastic, aluminium, which can be dismantled, sorted and recycled in accordance with the Waste Act at the end of the life of the equipment or when it is no longer functional.

The equipment can also be handed over as a whole in a collection yard.

ITEM CHECKLIST

3

Before starting, check that all the following items have been included with your laser system. If anything is missing, contact your supplier.

ITEM	NUMBER OF UNITS	DESCRIPTIONS
	1x KVANT Atom XR Laser Display System	2x Set of Safety Keys
	1x Emergency STOP remote US version / EU version BUS ID: 1647 / BUS ID: 1648	1x Network Signal Cable (cat5, IP65) BUS ID: 15-0801
	1x 3-pin XLR Emergency Stop Remote Cable (IP65) BUS ID: 15-0802	1x User manual USB drive BUS ID: 1054
	1x Remote Interlock Bypass (for USA only) BUS ID: 15-0867	1x QC Certificate
	1x AC Power cable with powerCon TRUE1 connector (IP65) BUS ID: 15-0013(US), 15-0213(EU), 15-0433(UK)	1x Heavy duty flight case (for 1 laser) Dimensions: 629*407*245mm BUS ID: 12-0035
		
		
		
		
		

OPTIONAL ACCESSORIES

Here is a list of optional accessories that are compatible with Atom XR laser system.

ITEM — DESCRIPTIONS

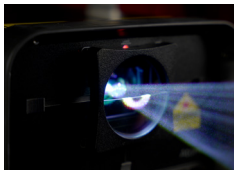

SafetyScan lens attachment bracket (lens is not included). This item is compatible only with this model version.

An aiming piece with a spirit level



DiscoScan lens attachment bracket (lens is not included). This item is compatible only with this model version.

PASS (Professional Audience Safety System) Card Integration

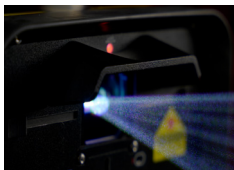

Aperture window cover

Beyond upgrade



SYSTEM OVERVIEW

5

KVANT Atom XR is a full colour, semiconductor diode laser system designed for professional laser displays.

When operated correctly and in the right conditions the Atom XR laser system is able to deliver a strong performance in large indoor and outdoor venues. The Atom XR can display virtually any colour within the basic RGB palette and its secondary mixed colours including white.

The system is air-cooled and designed so that there is no airflow going through the optical compartment of the system. This ensures that all important optical parts of the system stay clean for longer, keeping the maintenance time down to a minimum. This is a real advantage for all the venues where lots of smoke or haze is used on a daily basis.

This laser is IP rated up to IP65. It is however important to understand that this system must not be exposed to extreme temperatures, snow or excessive amounts of dust, as well as be used in outdoor environment for prolonged periods of time.



The manufacturer declares an IP65 rating for this product only when it is used in conjunction with the IP65-rated SEETRONIC cables supplied with the projector.

Use of any cables other than those provided may compromise the ingress protection of the device and result in a lower level of protection against dust and water.



1. LASER APERTURE

To clean the laser aperture window from inside or to swap the aperture plate for different type of aperture (i.e. DiscoScan lens attachment bracket), remove the four socket bolts that hold the laser aperture in place and remove it.

2. APERTURE MASKING PLATE

This metal masking plate can be moved left and right.

3. ATTACHMENT BRACKET

A 360-degree swivel-sliding mounting bracket with a robust fastening mechanism enables comfortable handling and flexible and secure positioning.

4. LASER EMISSION INDICATOR

When this indicator is lit up the laser system is ready to emit the laser radiation as soon as it receives instructions from control software.

5. STROBE LEDS

The strobe LEDs are located at the front of the laser device, next to the aperture window, and function as a visual identifier. Each diode is individually controlled via DMX and is pre-assigned to DMX channels 17–20, aiding in device identification in multi-unit or low-visibility environments.



1. MAINS POWER INPUT/OUTPUT

Use supplied Neutrik powerCON TRUE1 power cable to connect the laser system to mains power supply using the INPUT connector. The OUTPUT connector is used to daisy chain power between multiple laser systems for quick and easy installation. **The powerCON TRUE1** is a connector with breaking capacity (CBC), i.e. it can be connected or disconnected under load or live.

2. E-STOP REMOTE CONNECTOR, INTERLOCK STATUS INDICATOR AND USER INTERLOCK.

In order to use the laser system, the Interlock must be closed circuit. This is done by connecting the Emergency STOP Remote to the XLR REMOTE INPUT socket on the projector using the supplied cable. The US version of the Emergency STOP must also have the Remote Interlock Bypass inserted into it.

The Remote Interlock Bypass may be replaced by the user's own interlock system using a switch or dry relay closure to connect pins 1 and 2. With pins 1 and 2 shorted, Laser Emission is possible, provided all other interlocks are closed circuit. With pins 1 and 2 open, NO Laser Emission is possible.

The Interlock status indicator **START (2)** goes off and status indicator **READY (2)** lights up when the Interlock is closed circuit and the Interlock key is in the ON position. All above must be done correctly to allow laser emission from the system.

The projector's REMOTE Output is used to daisy-chain the Remote signal when you want to use a single Emergency STOP Remote to control multiple systems.

After a power failure or interlock failure (open circuit) has occurred and been corrected you need to manually reset laser emission by pressing the **START** button on the E-STOP Remote. Laser emission will then be available after a 60 second delay.



The E-STOP Remote is an integral part of the laser projector. It is there for the safety of the public as well as the operator. In most countries it is required by law to have a fully working Emergency STOP in place for every laser system used. Modifying or using anything other than the E-STOP Remote provided, in the manner it was intended, may invalidate your laser projector's variance.

3. SAFETY KEY SWITCH

The Safety key must be inserted and turned to ON position in order to enable the system to operate.

7. SAFETY EYELET

Retractable safety rope

4. DMX INPUT/THROUGH

Use these ports to connect DMX control signal or to daisy chain the DMX signal between multiple laser display systems.

8. SD CARD

If your laser projector is upgraded with ILDA connectors, the SD card will be located at the front of the laser projector, near Laser Emission Indicator.

5. ETHERNET

Use these ports to connect PC control signal or to daisy chain the control signal between multiple laser display systems.

9. ATTACHMENT BRACKET

A 360-degree swivel-sliding mounting bracket with a robust fastening mechanism enables comfortable handling and flexible and secure positioning.

6. FB4 LASER CONTROL INTERFACE

The inbuilt control interface allows you to control the laser via Ethernet and DMX/ArtNet, but it also handles all the basic settings of the laser system (master size and positions, method of control, colour settings etc.). All of these settings can be accessed through the menu using the endless rotary knob and once saved, they are stored on included mini SD card.

Please note: The information LEDs on the interface may vary depending on whether the laser projector is equipped with telemetry.

Without telemetry

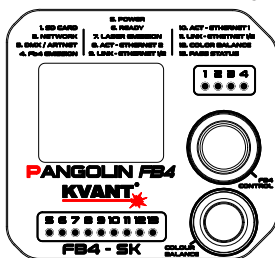

With telemetry

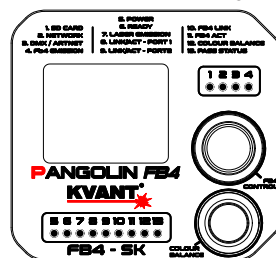

Act - activity
Link - connection



The intent of laser manufactures is to produce a laser diode driver with as linear response behaviour as possible, so when the diode current increases, the optical power and light intensity grow linearly.

However, the human eye senses brightness of light logarithmically over a moderate range (Weber–Fechner law). So when light intensity grows linearly, human eye and brain doesn't perceive it as a linear increase, and our visual perception of colours changes.



In the world of laser display systems this generates challenges when we work with mixed colours (i.e. yellow, magenta etc.). Normally the mixed colours coming out of laser systems do not directly correspond with those we see on computer screens – because of the difference in visual perception.

In order to synchronise all the colours we see on our screen and those coming out of the laser device we do, so called, palette calibration procedure in the laser control software. This can be of course rather lengthy process and even if it's done properly, the calibrated palette will always be tied to particular control system or profile that was used during the colour calibration and not to the laser projector itself. So we came with the idea to hard-code the “calibrated palette” into every laser system in our factory during the manufacture.

No matter what control interface you use or what control signal is used (Ethernet, DMX, ILDA), the calibrated palette is always there, ready for you to be switched on by Colour Balance button.

Telemetry provides real-time online monitoring and historical records of the laser projector, enabling remote observation of its status and operating conditions.

The telemetry system collects data from the integrated sensors and internal functions to support performance tracking, environmental monitoring, troubleshooting, and security-related events.

Because of the integrated backup battery, key information is collected and retained even during power interruptions, ensuring continuous insight into the device's condition and history.

The main telemetry features:

- GPS location information
- Accelerometer (acceleration, tilt angle, fall detection) - active at all times
- Temperature and humidity sensors (detect and record minimum and maximum values) - active at all times
- Lid and safety key status sensors (register if the lid was opened and the status of the safety key lock) - active at all times

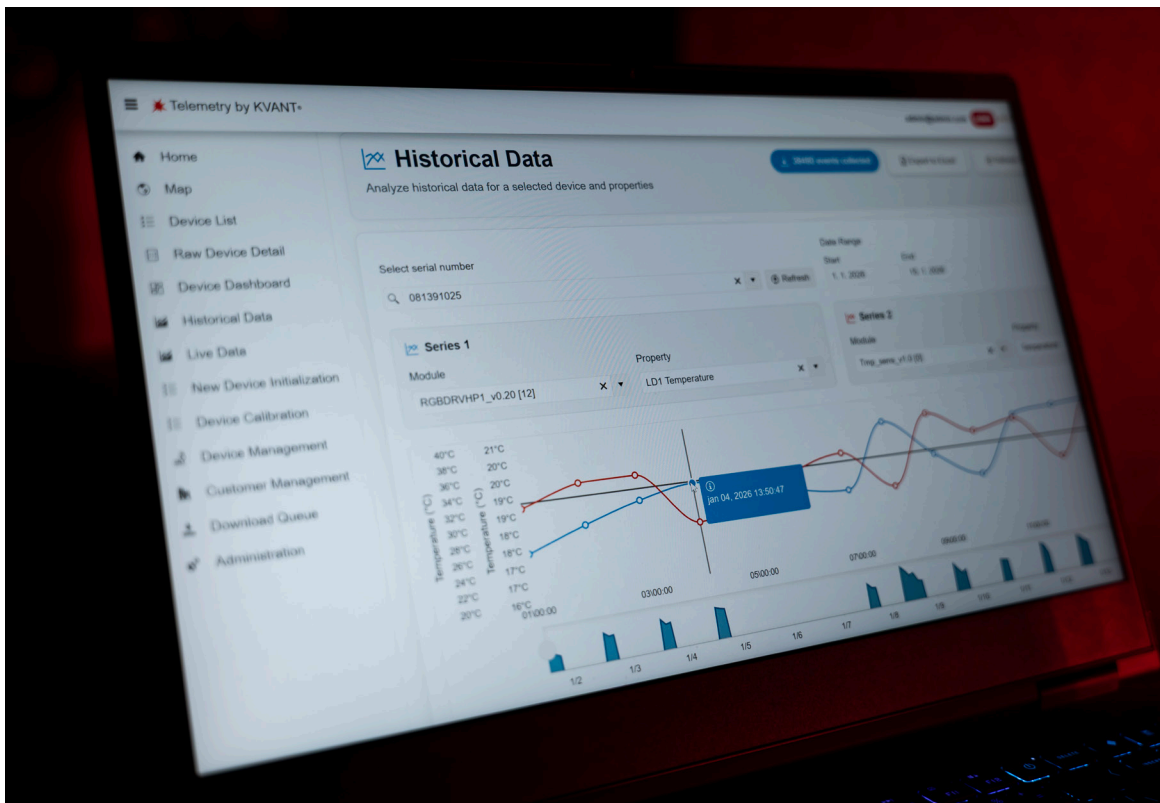

BEAM ALIGNMENT PRINCIPLE

7



Please read the following information carefully and take your time to process them! If you are not 100% certain that you understand the beam alignment principle, **DO NOT ATTEMPT** to proceed with the beam alignment by yourself. Instead, contact our servicing department for help.

The beam alignment is a process of pointing the beams coming out of laser modules inside your laser projector to the exact spot outside of the projector. If the colours are separated, the alignment must be made to ensure that all the mixed-colour projections are sharp and unified.

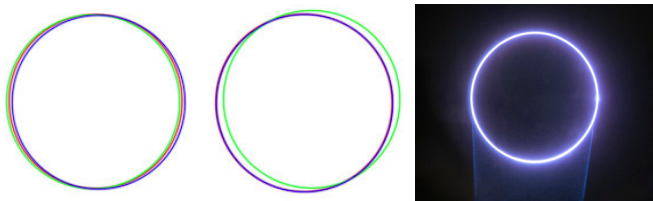

The final result is heavily dependent on each beam's parameters, such as its shape (circular, square, rectangular), initial size and divergence. If one is different in shape, size or divergence from another, the result won't be perfect even if the alignment was done correctly.

When aligning laser modules with various beam profiles, sizes and divergences, it is always good to cross-check different colours during the alignment. This is because better matching beams are always aligned easily and more precisely.

There are, for sure, many ways how to accomplish good alignment results. However, the following general instructions are based on our own experience.



Follow all the laser safety regulations and guidelines for servicing Class 4 laser devices. Wear eye protection and be aware of residual beams and reflections when working with the optical compartment opened.

OPTICAL SCHEMATIC OF THE ATOM XR PROJECTOR

The beam path in the Atom XR projector is as follows:

- Module 1 → reflection via Mirror 1 (Unice adjustment table, movement in both X and Y axes) → Polarizing cube
- Module 2 → passes directly through the Polarizing Cube (reference beam)
- Polarizing cube → mounted on a motorized adjustment table
- Mirror 2 → reflects the resulting combined beam onto the scanners

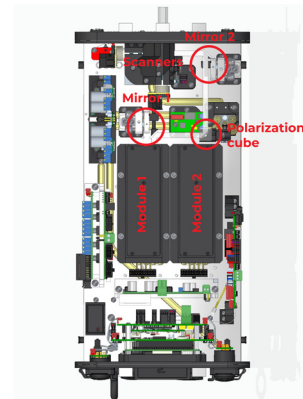

Unlike other Kvant projectors, the Atom XR projector does not allow for separate adjustment of individual colors (R, G, B). The laser modules are fixed and cannot be adjusted internally. Adjustment is performed exclusively at the level of the entire white beam of each module.

BEFORE STARTING BEAM ALIGNMENT

Remove the screws on the edge of the back panel and remove the edge cover.

Remove the screws on the back panel.

Then slide the laser body from the chassis and you will be able to see the interlock and flip it to the side until it touches the other side. You will be able to read the warning label "Interlock Defeated".

Power up the system as normal.

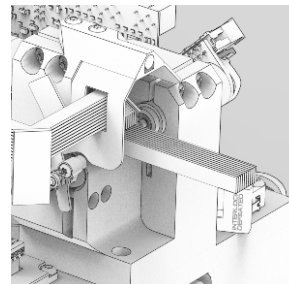

Interlock closed

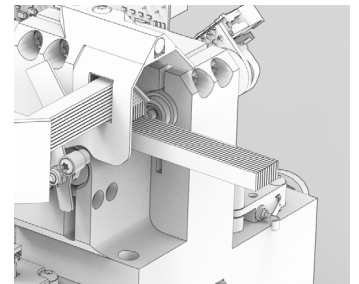

Interlock open

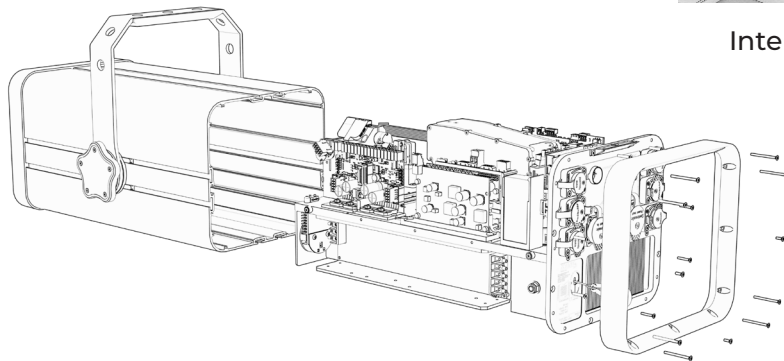

In the defeated position the label "INTERLOCK DEFEATED" becomes visible as shown in the image. Placing the magnetic interlock in the defeated position raises the interlock higher than the edge of the housing which will not allow the cover to be installed.

BEAM ALIGNMENT PROCEDURE FOR ATOM XR

1. Setting the Reference Beam (Module 2)

The beam from Module 2 passes directly through the polarization cube. For simplicity, adjust the polarization cube (motorized stage) so that the beam from Module 2 passes exactly through the center of the cube. This beam serves as the reference (master) beam, to which the beam from Module 1 will be aligned.

2. Aligning the beam from Module 1 using Mirror 1

Mirror 1 is attached to the Unice adjustment stand, which allows movement along both the X and Y axes. Using the Unice stand, adjust the reflection of the beam from Module 1 so that the two beams intersect on the polarizing cube, so that the beam from Module 1 meets the beam from Module 2.

3. Fine-tuning the polarization cube

Once the beams intersect on the cube, fine-tune the cube using the motorized stage so that the resulting combined beam is as precise as possible.

4. Checking the result using scanners

Set the circle effect in the control software and project it to the greatest possible distance (at least 6 meters). If the alignment is correct, the result is a single sharp and uniform circle.

- One circle → alignment is complete.
- Two circles → proceed to step 5.

5. Backward iteration (two visible circles)

Check the intersection of the beams directly on the polarization cube:

1. If you see two separate beams on the cube (the intersection is not correct): fine-tune Mirror 1 using the Unice stand so that the beam from Module 1 precisely meets the beam from Module 2.
2. Then fine-tune the cube's motorized stand so that the result on the projection screen is a single circle.
3. If the alignment on the cube looks okay, adjust the cube's motorized base directly.

6. Final Check

Check the result from a greater distance. The projected circle must be a single, sharp, and uniform circle around the entire circumference. If necessary, repeat steps 2 through 5.

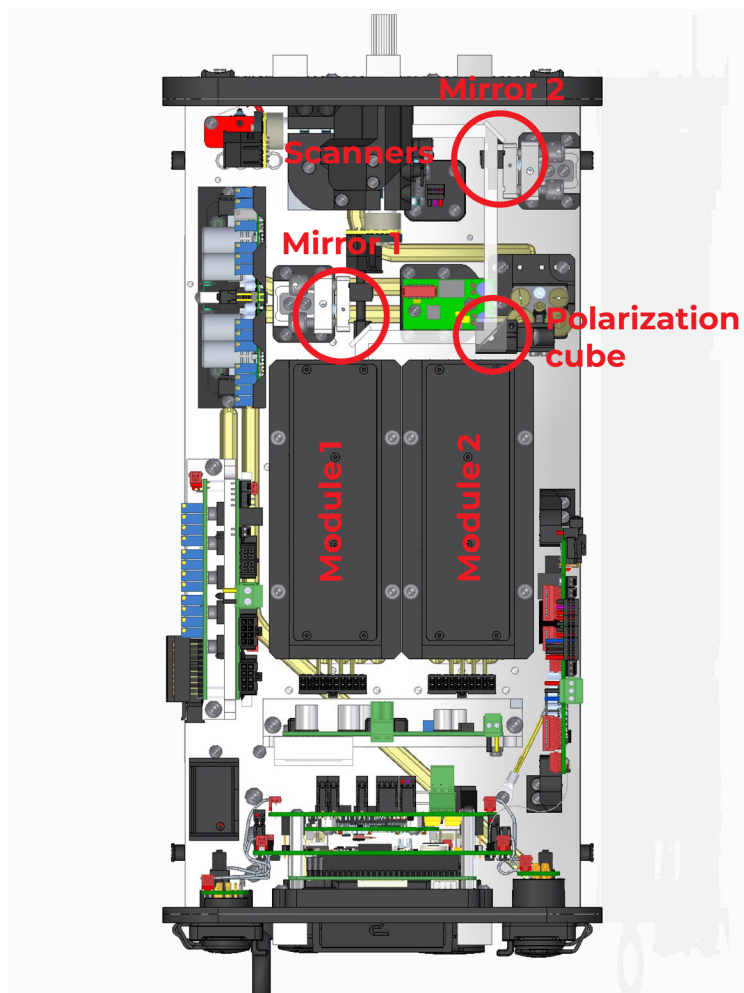

BEAM ALIGNMENT WITH MOTORISED DICHROIC FILTERS

7.1

ADJUSTING COLOURS DIRECTLY FROM ATOM XR INTERFACE



A: Power up the system as standard.



B: Create a full-size white circle (static tunnel effect).

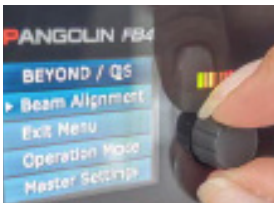

C: Find Beam Alignment option in the menu and enter it by pressing the rotary knob.

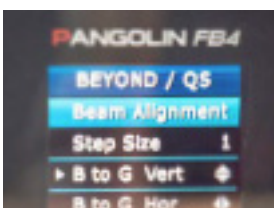

D: Here you can set the STEP SIZE (amount of movement in a single step), and VERTICAL/HORIZONTAL movement for every colour in your projector (R=RED, G=GREEN, B=BLUE, Y=YELLOW).

ADJUSTING COLOURS FROM BEYOND SOFTWARE

Beyond automatically identifies Motorised Dichroic Filters when the laser projector is connected (and powered up) to the PC via Ethernet.



A: Power up the system as standard and create a full-size white circle (static tunnel effect).

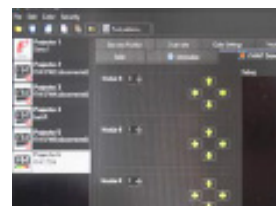

B: Go to: PROJECTOR SETTINGS -> KVANT DICHRO tab. There you will find all the information and control options for the dichroic filters.

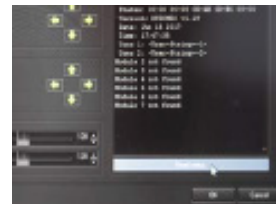

C: To start the beam alignment, press the READ STATUS button.



D: Start with the first dichroic filter (laser module) and/or any other as necessary. Use the arrows associated with each module to move the beam to the desired position.



When the alignment procedure is successful, you will see all the colours nicely overlaying each other, resulting in an even, bright and sharp white circle.

COLOUR BALANCE DISPLAY MODE

8

This chapter provides precise and detailed step-by-step instructions for creating virtual control buttons for the Colour Balance function in BEYOND software. The configuration uses a combination of the internal PangoScript scripting tool and the OSC communication protocol to directly control the FB4 hardware controller.

By properly setting up these technologies, laser system operators gain a powerful tool that allows them to dynamically and instantly change the colour palette of the laser output directly from the main software interface. This capability is crucial for live performances and situations requiring quick creative editing of visuals.

Before beginning any configuration, it is absolutely essential to familiarise yourself with the critical safety requirements described in the following chapter.



Please note that these instructions can be performed only with a Beyond Advanced or Lifetime license.

CRITICAL SAFETY REQUIREMENT: PRESENCE OF THE CBLUT.TXT FILE

The strategic importance of this step for safe operation of the entire system cannot be overemphasised. The following warning is the most important part of the entire process. Ignoring it can lead to dangerous conditions that compromise safety and may cause permanent damage to the laser device.

MANDATORY PRESENCE OF THE CBLUT.txt FILE

For safe and correct use of the Colour Balance function, it is essential and mandatory that a file named CBLUT.txt be stored in the relevant FB4 controller directory.

- **File function:** CBLUT.txt defines the exact levels of individual colours (colourpalette) that the system should use when activating the Colour Balance function. It essentially serves as a preset map of safe values.
- **Hazard description:** If the CBLUT.txt file is missing from the controller's memory and the function is activated anyway, the FB4 controller will send the maximum (MAX) power to the output, even at the minimum blanking signal level.

This means that the controller will command the laser diodes to emit 100% of their rated power, bypassing all software intensity controls. This uncontrolled full-power emission can cause immediate and catastrophic thermal damage to the scanner's galvanometers and other optical components, resulting in costly repairs and significant system downtime.

Only after thoroughly verifying that the CBLUT.txt file is correctly loaded in each FB4 controller you plan to control is it safe to proceed with the communication interface configuration.

STEP 1: CONFIGURING OSC COMMUNICATION

The OSC (Open Sound Control) protocol serves as the basic communication bridge between the BEYOND software and the FB4 hardware controller. Without the correct configuration of this communication, the commands that we will later create using PangoScript will never be delivered to the target device. Follow the steps below.

1. In the BEYOND main menu, click on Settings.
2. From the drop-down menu, go to OSC.
3. In the subsequent submenu, select OSC Settings...

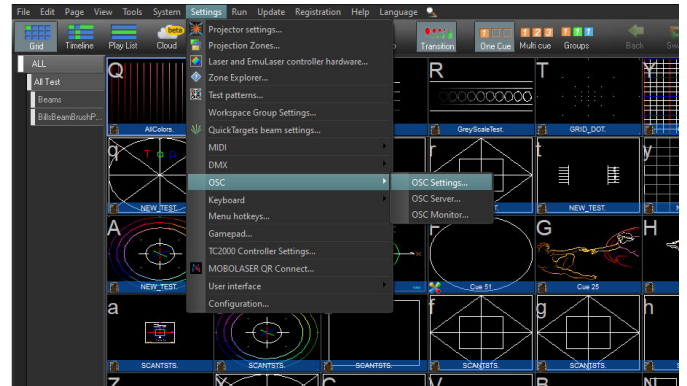

The "OSC Settings" configuration window will open, where you need to enable two-way communication and set the destination address.

- Check both boxes: "**Enable receiving OSC messages**" and "**Enable outgoing communication**". This step allows the software to receive and send commands via the OSC protocol.
- In the "**Destination IP**" field, set the value to 255.255.255.255. Using this broadcast address is a strategic choice for operational efficiency. It eliminates the need for individual IP address management and allows a single command to be universally received by all FB4 controllers on the network, which is invaluable during setup and live operation.

After making these changes, confirm the settings by clicking the OK button. Once communication has been successfully set up, the next step is to create the control scripts themselves.

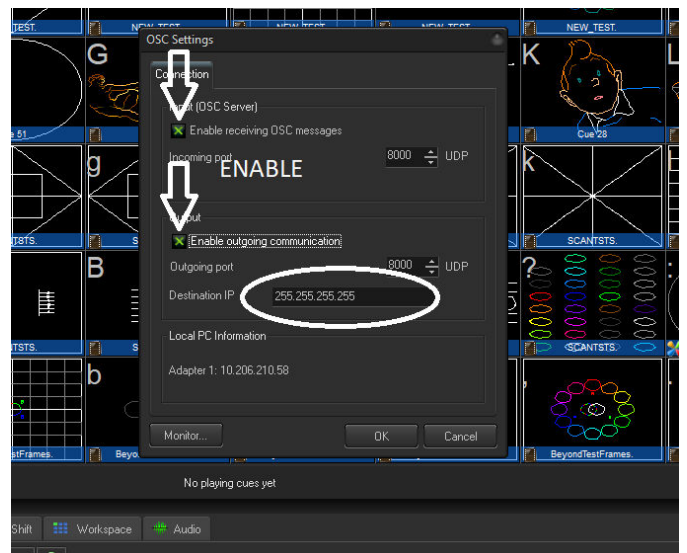

STEP 2: CREATING VIRTUAL BUTTONS USING PANGOSCRIPT

PangoScript is BEYOND's internal scripting language, which is a powerful tool for automating tasks and creating custom functions. In this step, we will use it to create two separate scripts that will function as virtual buttons in the user interface to turn the Colour Balance function on and off.

To open the PangoScript editor, proceed as follows:

1. In the right panel of the BEYOND main window, find and select the **PangoScript** tab.
2. Then click on the **"New code..."** icon to open the editor for inserting a new script.

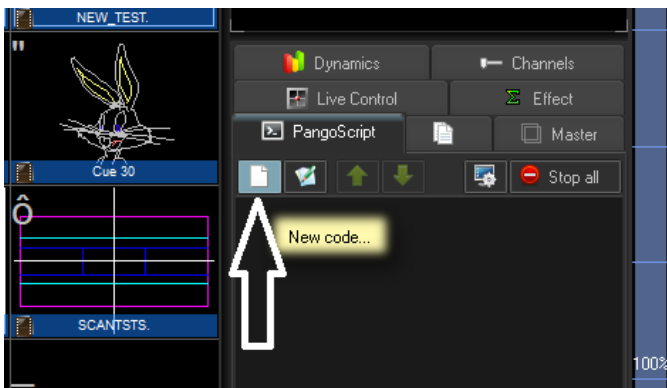
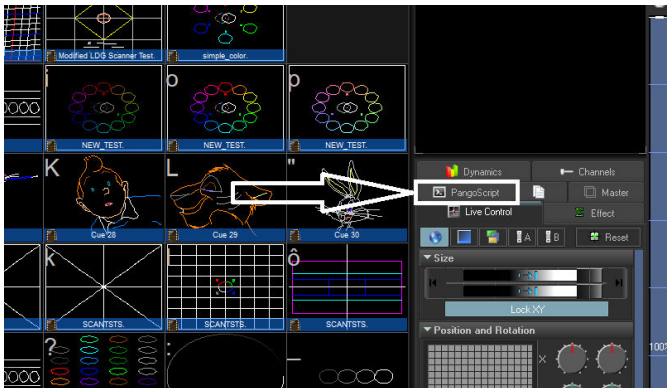

Analysis of the script structure

The scripts we will be creating consist of two key commands. Understanding their function is essential for proper implementation and possible future modifications.

- **CodeName "ButtonName"**: This command assigns a readable label to the script, which is displayed on a clickable button in the PangoScript interface. It is crucial to choose a clear and unambiguous name (e.g. **"CenterLaser_CB_ON"**) for quick identification during a live show.
- **OscOut `"/FB4-{SERIAL NUMBER}/kvan_magic_button", {value}`**: This is the core of the entire command, which sends an OSC message to the target device. Its syntax has two important parts:
 - `/FB4-{SERIAL NUMBER}/kvan_magic_button`: Defines the target address (path) of the command within the OSC protocol. The {SERIAL

NUMBER} part is a placeholder that must be replaced with the specific serial number of the target FB4 controller (e.g. 03691).

- `{value}`: The numerical value at the end of the command determines whether the function should be enabled or disabled. A value of **1** activates the Colour Balance function, while a value of **0** deactivates it.

Creating the "Colour Balance ON" button

1. Open the new script editor as described above.
2. Enter the following code into the text field. In the OscOut line `"/FB4-03691/..."` you must replace 03691 with the specific serial number of the target FB4 controller. This parameter is fixed and unique for each device.

Confirm the creation of the script by clicking the OK button. A new button called **"ColourBalance_ON"** will

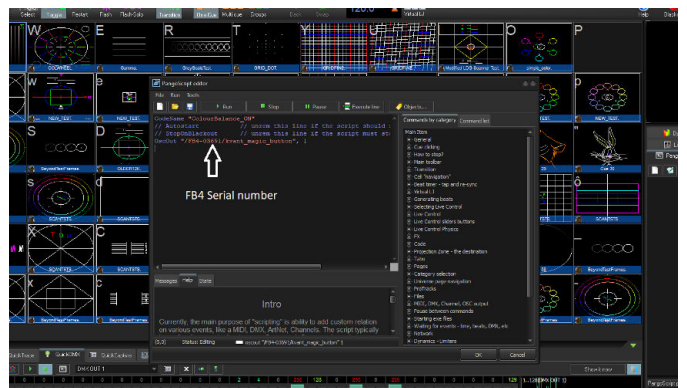

appear in the PangoScript panel.

Creating the "Colour Balance OFF" button

1. Repeat the procedure and create another new script.
2. Enter the code for turning off the function in the text field. The procedure is identical, only the name of the button and the numerical value of the command change.

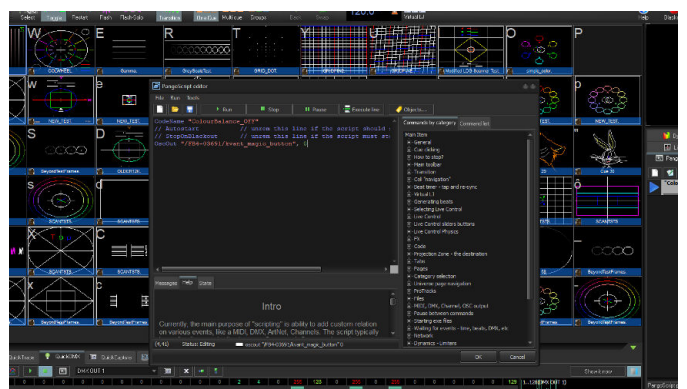

The key differences from the previous script are:

- CodeName is set to **"ColourBalance_OFF"** for unique identification.
- The value in the OscOut command is **0**, which signals the FB4 controller to deactivate the function.
- 3. Confirm the creation of the script by clicking **OK**.

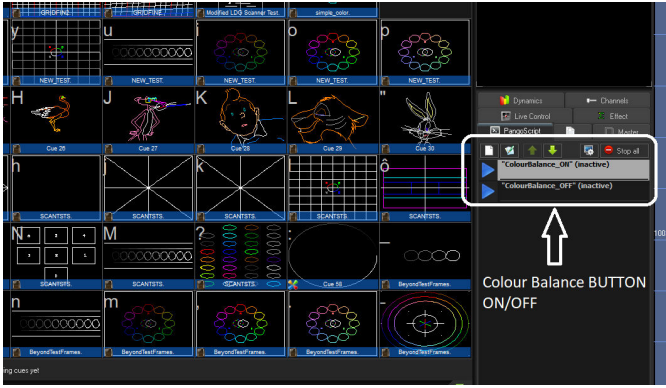

This procedure is fully functional for controlling a single laser system. The following chapter deals with its extension and application in larger assemblies with multiple lasers.

STEP 3: ADAPTATION FOR MULTIPLE LASER SYSTEMS

The basic principle of this configuration is that each PangoScript is permanently linked to a single FB4 controller via its unique serial number. To manage an array with multiple projectors, you must create a dedicated pair of scripts for each unit. If you do not do this, commands will only be sent to a single, specified device.

Follow these instructions:

1. **Identify serial numbers:** For each additional FB4 controller in your setup, find its unique serial number.
2. **Create new scripts:** For each additional controller, you need to create a new pair of PangoScripts (one for activation ON, the other for deactivation OFF), as in step 2.
3. **Modify the code:** Two key elements need to be modified in the script copy:
 - **CodeName:** We strongly recommend adding a unique laser identifier to the name to maintain clarity in the interface (e.g. CodeName "Laser2_ColourBalance_ON").
 - **Path in OscOut:** Replace the original serial number (e.g. 03691) with the serial number of the new laser (e.g. OscOut "/FB4-12345/kvant_magic_button", 1).

After completing these steps for all devices, the operator will have full and individual control over the Colour Balance function for each laser in their setup directly from the PangoScript panel.

CONCLUSION AND FUNCTIONALITY VERIFICATION

If you have followed all the steps in this guide, you have successfully configured OSC communication and created functional PangoScripts to remotely control the Colour Balance function on your FB4 controllers.

You can visually verify the successful configuration by looking at the PangoScript panel in the right-hand menu of the BEYOND software. You should see all the newly created virtual buttons here, such as "**ColourBalance_ON**" and "**ColourBalance_OFF**".

Clicking on these buttons immediately sends the corresponding OSC command to the target FB4 controller, activating or deactivating the desired colour palette.

Finally, we would like to remind you once again that the presence of the **CBLUT.txt** configuration file in the memory of each controlled FB4 controller is absolutely essential for the safe and correct functioning of the entire system.

ANOTHER METHOD: VIA FB4 INTERFACE

Alternatively, you can configure the Color Balance by opening Color Settings in the FB4 Interface located on the rear panel of the projector, then selecting Color Balance.



TECHNICAL SPECIFICATIONS

9

All the technical specifications are subject to change without prior notice.

LD

Low Divergence upgrade affects the laser beam, so it is a bit thicker at the source, but much more coherent further away. And that makes it more than twice as bright and visible at a distance when compared to standard laser display systems.

RGBY

RGBY labelled systems come with an extra OPSL module inside - the one that outputs 577nm yellow laser. In simple terms, adding yellow to the mix broadens your lighting design colour palette with more vivid colours and increases LUX level, which means brightness!

HPS

High performance system. Upgrade for ultimate laser graphic and animation systems featuring 60kpps X-Y galvo Saturn1 scanning system.

BB

BeamBrush gives you instant zoom, wash, waving and positioning; combined with the razor sharp coherent profile of laser. So you can move from a classical moving head appearance, to a razor sharp laser look, instantaneously.

TECHNICAL SPECIFICATIONS

ATOM XR 18W

9.1

KVANT Atom XR 30W – full colour, semiconductor diode laser system

Total Optical Power (installed): **18.5W**

Total Optical Power (guaranteed): **17.5W***

*Due to Advanced Optical Correction technology used in our laser systems the optical power output of each laser colour within the system may slightly differ from the specification of respective laser module(s) installed. This does not affect the guaranteed total power output.

NOHD (Nominal Ocular Hazard Distance for guaranteed power output): **1331 m**

Beam diameter at laser aperture: **7x7 mm**

Beam divergence: **1.1 mrad** (full angle)

Red: 0.5/0.5 mrad

Green: 0.5/0.5 mrad

Blue: 0.6/0.6 mrad

Modulation: 100 kHz | analog – 100 kHz

Module cooling: TEC

Scanning System: **Juno 5 | 30 kpps @ 8°, max. scanning angle 50° on both axes**

Colours	Module Type	Wavelength	Power installed
Red	-	638nm	4 000mW
Green	-	525nm	5 500mW
Blue	-	455nm	9 000mW
Total			18 500mW

Laser safety features: Keyed interlock, emission delay, interlock microswitch, scan-fail safety, fast electromechanical shutter | reaction time <20ms, adjustable aperture masking plate. Emergency STOP system with keyed remote and manual RESTART button.

This laser system fully complies with the latest **EN 60825-1:2014**, **FDA** regulations and **TUV Laser Safety**.

Control signal: Ethernet, DMX/ArtNet, SD card (via inbuilt FB4 control interface)

Power requirements: **100-240/50-60Hz | Neutrik powerCON TRUE1**

Consumption (MAX): **100-240V DC**

Operation temperature: **0-40°C**

Ingress protection rating: **IP65**

Dimensions (WxDxH): **209 x 194 x 408 mm**

Weight: **14 kg** without handle

TECHNICAL SPECIFICATIONS

ATOM XR 30W

9.2

KVANT Atom XR 30W – full colour, semiconductor diode laser system

Total Optical Power (installed): **31W**

Total Optical Power (guaranteed): **30W***

*Due to Advanced Optical Correction technology used in our laser systems the optical power output of each laser colour within the system may slightly differ from the specification of respective laser module(s) installed. This does not affect the guaranteed total power output.

NOHD (Nominal Ocular Hazard Distance for guaranteed power output): **1852 m**

Beam diameter at laser aperture: **10x7 mm**

Beam divergence: **≤1.05 mrad** (full angle)

Red: 0.5/0.5 mrad

Green: 0.5/0.5 mrad

Blue: 0.6/0.6 mrad

Modulation: 100 kHz | analog – 100 kHz

Module cooling: TEC

Scanning System: **Juno 5 | 30 kpps @ 8°, max. scanning angle 40° on both axes**

Colours	Module Type	Wavelength	Power installed
Red	-	638nm	7 000mW
Green	-	525nm	10 000mW
Blue	-	455nm	13 000mW
Total			30 000mW

Laser safety features: Keyed interlock, emission delay, interlock microswitch, scan-fail safety, fast electromechanical shutter | reaction time <20ms, adjustable aperture masking plate. Emergency STOP system with keyed remote and manual RESTART button.

This laser system fully complies with the latest **EN 60825-1:2014**, **FDA** regulations and **TUV Laser Safety**.

Control signal: Ethernet, DMX/ArtNet, SD card (via inbuilt FB4 control interface)

Power requirements: **100-240/50-60Hz | Neutrik powerCON TRUE1**

Consumption (MAX): **100-240V DC**

Operation temperature: **0-40°C**

Ingress protection rating: **IP65**

Dimensions (WxDxH): **209 × 194 × 408 mm**

Weight: **14 kg** without handle

TECHNICAL SPECIFICATIONS

ATOM XR 60W

9.3

KVANT Atom XR 60W – full colour, semiconductor diode laser system

Total Optical Power (installed): **62W**

Total Optical Power (guaranteed): **60W***

*Due to Advanced Optical Correction technology used in our laser systems the optical power output of each laser colour within the system may slightly differ from the specification of respective laser module(s) installed. This does not affect the guaranteed total power output.

Colours	Module Type	Wavelength	Power installed
Red	-	638nm	14 000mW
Green	-	525nm	20 000mW
Blue	-	455nm	26 000mW
Total			60 000mW

Laser safety features: Keyed interlock, emission delay, interlock microswitch, scan-fail safety, fast electromechanical shutter | reaction time <20ms, adjustable aperture masking plate. Emergency STOP system with keyed remote and manual RESTART button.

This laser system fully complies with the latest **EN 60825-1:2014**, **FDA** regulations and **TUV Laser Safety**.

NOHD (Nominal Ocular Hazard Distance for guaranteed power output): **2623 m**

Beam diameter at laser aperture: **10x7 mm**

Beam divergence: **≤1.05 mrad** (full angle)

Red: 0.5/0.5 mrad

Green: 0.5/0.5 mrad

Blue: 0.6/0.6 mrad

Modulation: 100 kHz | analog – 100 kHz

Module cooling: TEC

Scanning System: **Juno 5 | 30 kpps @ 8°, max. scanning angle 40° on both axes**

Control signal: Ethernet, DMX/ArtNet, SD card (via inbuilt FB4 control interface)

Power requirements: **100-240/50-60Hz | Neutrik powerCON TRUE1**

Consumption (MAX): **100-240V DC**

Operation temperature: **0-40°C**

Ingress protection rating: **IP65**

Dimensions (WxDxH): **209 × 194 × 408 mm**

Weight: **15 kg** without handle

MY PROJECTOR'S APERTURE GLASS IS CRACKED, BROKEN OR MISSING. CAN I CONTINUE USING MY PROJECTOR?

Laser beams hitting glass splits will be scattered into unwanted directions, creating a risk of damage to eyesight, health or property. Broken or missing aperture glass enables humidity, water, and dust inside the laser projector's optical compartment, which can cause permanent damage to the system.

It is essential to replace the damaged or missing aperture glass before using the laser projector.

THE HOUSING OF THE PROJECTOR IS DAMAGED. CAN I CONTINUE USING MY PROJECTOR?

The projector must not be operated if the housing is damaged to the level that it causes visible gaps between the projector's adjacent faces. The gaps enable humidity, water, and dust inside the laser projector's optical compartment, which can cause permanent damage to the system. There is also a risk of laser emission leaks from other parts of the system, which contradicts the IEC 60825-1 safety standard. Damaged housing parts must be repaired or replaced before operating the projector again.

PROJECTOR'S EYEBOLT IS BENT, FRACTURED OR UNSCREWED. CAN I CONTINUE USING MY PROJECTOR IF IT IS INSTALLED USING THE EYEBOLT AS A SAFETY MECHANISM? OR CONTINUE WITH THE INSTALLATION?

No! The projector must not be used, lifted or hanged. Never attempt to repair bent or fractured eyebolt. Replace it with a new one with the same or higher load capacity.

IS IT OK THAT THE COOLING FANS ARE NOT RUNNING DURING OPERATION?

Yes, it's OK. Kvant projectors have built-in automatic regulation of the fan speed. After powering up the projector, all cooling fans will run at 100% speed for about 2 seconds. Then their speed is adjusted according to the heatsink's temperature.

Clubmax (without FB4): if heatsink's temperature is below 25°C (77°F), the fans are turned off. Within the range of 25°C (77°F) to 55°C (131°F), the fan speed increases with increasing temperature of the heatsink, and over 55°C (131°F) they run at full speed.

BeamBrush, Clubmax FB4, Atom and Spectrum series: if heatsink's temperature is below 15°C (59°F), the fans are turned off or run at low speed. Within the range of 15°C (59°F) to 33°C (91°F), the fan speed increases with increasing temperature of the heatsink, and over 33°C (91°F) they run at full speed.

IS IT OK IF SOME FANS ARE RUNNING AT FULL SPEED AND SOME AT LOW SPEED DURING THE OPERATION?

Yes, it is OK. Kvant Atom and Spectrum projectors use multi-zone regulation of the fan speeds. Fans that cool down warmer sections of the heatsink work at higher speeds. The correct functionality of all fans can be checked anytime by power cycling the projector. After powering up the projector, all cooling fans will run at 100% speed for about 2 seconds. Then their speed is adjusted according to the heatsink's temperature.

COOLING FANS GENERATE A STRANGE NOISE. IS THAT A PROBLEM?

Strange noise is usually caused by an object stacked in the fan's propeller area. It can be a piece of confetti or plastic or even a hardened mixture of smoke residue and dust. Check the fans and if such an obstruction is found, turn the projector off and remove it. Another reason for the noisy fans could be its damaged propeller or bearings. If that's the case, then the fan needs to be replaced with a new one of the same type.

SHUTTER DOESN'T OPEN, AND ITS PLATE BLOCKS THE OUTPUT (IN ILDA OPERATION MODE).

In the ILDA operation mode, the shutter is also controlled with the "shutter" signal from an external controller. Check the ILDA cable, mainly if pin #13 is connecting properly. We recommend using only original ILDA cables.

SHUTTER DOESN'T OPEN, AND ITS PLATE BLOCKS THE OUTPUT.

If the shutter doesn't open in any operation mode, please contact your distributor or technical assistance of Kvant Lasers, s.r.o.

THE PROJECTOR IS POWERED ON, READY FOR EMISSION, BUT THE FB4 DISPLAY IS INACTIVE. AND IT DOESN'T TURN ON AFTER PUSHING OR TURNING THE ENCODER KNOB NEXT TO THE FB4 DISPLAY.

Perform a power cycle procedure with the mains power switch or unplugging the mains power cable for 5 seconds. After the power cycle, the display should start working correctly.

ONE OF THE RGB COLOURS DOESN'T WORK.

Check colour settings in the FB4 menu and make sure that all R, G and B colours are set at 100%. If the projector doesn't have a built-in FB4 controller, check the brightness potentiometers at the rear panel - all three should be set to the maximum level.

If all the above is as described and the problem persists, turn off the mains power switch (or disconnect the mains power cord) for 10 minutes.

All PSUs should fully discharge and cool down. After 10 minutes, power up the projector. If overloaded PSUs caused the malfunction, it should now work correctly again.

ONE OF THE RGB COLOURS DOESN'T WORK (ILDA OPERATION MODE ONLY).

Check connection on both ends of the ILDA cable and inspect the ILDA male connector's pins.

SCANNING IS UNSTABLE OR DISTORTED ON BOTH THE X AND Y AXES (ILDA OPERATION MODE ONLY).

Distortion of the scanned effects can occur when the projector and the PC (controller) are not connected to the same mains power phase due to different PE wire potentials (Earth).

Always connect the PC/controller and the laser projector to the same mains power socket when operating in ILDA mode.

THE PROJECTION SIZE IS REDUCED TO ABOUT 50% ON ONE OR BOTH OF THE X AND Y AXES.

Check Master Settings in the FB4 menu and ensure both axes size are set to 100% size. If the projector doesn't have FB4 controller build-in, ensure both X and Y potentiometers located on the rear panel are set to the maximum level. If all the above is as described and the problem persists, check ILDA cable connectors on both sides and the ILDA input connector on the projector. One or more of #1, #2, #14, #15 pins may be bent or damaged.

ONE COLOUR OF THE PROJECTED EFFECT IS SHIFTED OUT FROM OTHERS - MISALIGNED.

It is necessary to reset the output directions (alignment) of individual colours (laser beams) inside the projector. There are several ways how to join them together, but only one is correct. The correct one ensures perfectly joined beams at both short and long-distance projections. Please check the User manual (chapter Beam alignment) for beam alignment instructions.

PROJECTOR #2 DOESN'T WORK WHEN CONNECTED TO THE ILDA OUTPUT OF PROJECTOR #1.

Try to replace the ILDA cable with a new one between projectors and check the ILDA input connector on projector #2 for any damage. If this does not solve the issue, exchange the projectors one for another and see if that works. If both work fine, then projector #1 has faulty ILDA output. If none of them is working, then projector #2 has faulty ILDA input. Please contact your distributor or technical assistance of Kvant Lasers, s.r.o. for further help.

PROJECTION IS BLURRED OR FOGGY. STATIC BEAMS (POINTS) HAVE A HALO AROUND THEM. HOW TO FIX THIS?

This is usually an optical problem such as scratches, dust and dirt on the components on the beams' path from their source to the output aperture; or on the aperture glass itself. Use a clean fine-cotton cloth soaked with isopropyl alcohol to clean the surface of the output window. Clean it carefully so you won't scratch the surface with dirt particles already stacked to the cloth.

Remember that the output window's anti-reflex surface can be easily scratched and permanently damaged by an incorrect cleaning process.

PROJECTION IS BLURRED OR FOGGY; STATIC BEAMS (POINTS) HAVE A HALO AROUND THEM, BUT THE OUTPUT WINDOW IS CLEAN. HOW TO FIX THIS?

This is usually an optical problem such as scratches, dust and dirt on the components on the beams' path from their source to the output aperture (scanner mirror, dichroic filter, bounce mirror). To inspect and clean the optical components, the projector must be turned off and disconnected from the mains power supply.

Use a clean cotton bud (swab) soaked with isopropyl alcohol to clean the optical component's surface. The bud must be "rotated" against movement direction during cleaning to avoid the surface get scratched by dust and dirt already taken from the surface. After one whole spin (360 deg), dispose of the cotton bud and take a new cotton bud to continue the cleaning process. Remember that the optical parts' surface can be easily scratched and permanently damaged by an incorrect cleaning process.

ONE OF THE COLOURS FADES OUT AND THEN GOES BACK TO ITS FULL POWER. THIS REPEATS. WHY IS THIS HAPPENING?

The laser projector has automatic over-temperature protection, decreasing the individual laser module's power output to 50% if its temperature goes above the preset level. After stabilization of temperature, the output power goes back to 100%. If the temperature at 50% power output still rises, the power output is cut to zero until the temperature returns to safe values.

If the projector reduces the power output of one or more colours, the reason for it could be insufficient cooling caused by lack of airflow, too warm cooling air, or faulty fans on the main heatsink.

THE PROJECTION SUDDENLY LOST A SIGNIFICANT AMOUNT OF BLUE COLOUR. THE COLOUR TONE OF ALL RGB EFFECTS CHANGED, AND THE TOTAL POWER OUTPUT DECREASED TOO. WHY?

The most likely reason is the activated Colour Balance function, which balances all the primary colours in the correct ration for all the mixed colours to be precisely right. For example, projected white is nice and crisp, without discolouration towards blue. To enable or disable this function, press the little button next to the FB4 display on the rear panel. This feature is switched ON when the yellow LED indicator next to this button is on. When the Colour Balance function is disabled, all the colours go back to 100% power output.

HOW MANY PROJECTORS CAN I DAISY-CHAIN WITH E-STOP REMOTE?

The number of projectors running on a single E-STOP Remote is unlimited. Each projector amplifies the E-STOP signal for the next projector in line.

WHAT IS THE MAXIMUM DISTANCE OF THE E-STOP CONNECTION BETWEEN TWO PROJECTORS?

The maximum length between two projectors is defined by the internal resistance of used cable connection wires. The total resistance of one wire within connection must be below 400 Ohm. Standard microphone XLR cables have resistance typically below 0,1 Ohm/meter. So the maximum distance between two projectors with such cable is approximately 4km.

HOW MANY PROJECTORS CAN I DAISY-CHAIN WITH A SINGLE ETHERNET LINE (PC OUT-> IN1, OUT1-> IN2, OUT2-> IN3...)?

We recommended daisy-chaining a maximum of 6 units on a single Ethernet line. If you connect more than six projectors, the data packet losses will most likely be noticeable, resulting in a disruptive movement of projected graphics and animations.

For the best possible quality of multi-laser data connection, it is recommended to use a high-speed 1Gbit data connection between PC and data switch. Also, it is recommended to separate 100Mbit data connections between the data switch and each projector.

IS IT POSSIBLE TO CONNECT A DOOR SWITCH AS A SAFETY MEASURE TO INTERRUPT THE LASER EMISSION?

Yes. Laser projectors supplied to the US market come with an E-STOP Remote with Auxiliary Input for Normally Closed (NC) door switch (Omron-D2HW-C231H).

Into this input, the client can connect either an interlock jumper, a door switch or any additional safety item, e.g. output of PIR sensor for observing the area around the laser projector.

IS THIS PROJECTOR COMPATIBLE WITH OTHER KVANT PROJECTORS?

All Kvant projectors manufactured from 06/2014 and later are fully compatible with each other. To check and ensure compatibility with older Kvant projectors made prior 05/2014, please contact the technical support representative of Kvant Lasers, s.r.o.

Suppose Spectrum LD projector with Saturn9 scanning set is used with non-LD projectors. In that case, it is recommended to decrease the maximum size and scan rate of the non-LD system(s) to meet the LD system limits and full compatibility. If more systems from various manufacturers are used together, it is recommended to use a separate ILDA signal source for each manufacturer's group.

THE PROJECTOR HAS BEEN EXPOSED TO RAIN DURING AN OUTDOOR SHOW WITHOUT THE RAIN COVER INSTALLED. WHAT SHALL I DO NEXT?

It is necessary to remove the laser projector from its flight case as soon as possible - within 24 hours at the latest after the show, and let both projector and flight case fully dry out.

NEVER turn ON the projector before it is 100% dry inside out.

When ready, please check the status of the anti-humidity cassette containing silica gel. For more information about this topic, go to the User manual (chapter Maintenance). Insufficient drying of the projector and its flight-case can cause permanent damage to the projector (mould, corrosion) and voids the warranty. Powering up wet or dump projector can cause electrical shock, injury, or fire risk. It can also cause permanent damage to the projector, in which case the warranty is voided.

IS THE RAIN COVER ACCESSORY SUITABLE FOR LONG TERM PROTECTION AGAINST OUTDOOR WEATHER CONDITIONS?

No. The Rain cover was designed as emergency protection against rain or snow for short term outdoor use. During intense precipitation and winds, it can get soaked with water. Therefore, removing the rain cover from the projector after every use and letting it dry together with the projector is necessary. Insufficient drying of the projector and its flight-case can cause permanent damage to the projector (mould, corrosion) and voids the warranty. Powering up wet or dump projector can cause electrical shock, injury, or fire risk. It can also cause permanent damage to the projector, in which case the warranty is voided.

IS IT POSSIBLE TO USE THE RAIN COVER FOR A PROJECTOR THAT IS SET OTHER THAN HORIZONTALLY (I.E. WHEN PROJECTING UPWARDS)?

No. Our Rain cover works efficiently ONLY for projectors set in a horizontal position - that's with rubber feet towards the ground.

If the Rain cover is used any other way, it won't protect your equipment.

AT LOW TEMPERATURES, THE LASER PROJECTOR WON'T START.

The operating temperature range for Kvant laser projectors is +10°C (50°F) to +35°C (95°F). If used outside of this range, we recommend using the Kvant Monsoon. This robust and durable enclosure will protect your delicate equipment, such as laser projectors, against harsh weather conditions, extreme temperatures and high humidity. As a temporary solution, you can use an electric heater to pre-heat the air entering the laser projector. Place the heater at the correct distance from the projector, so when the air enters the laser projector, it is within the range +10°C (50°F) to +25°C (77°F).

The projector may get damaged if the heater is placed too close to the projector's airflow inlets or rear control panel.

LASER PROJECTOR STOPS WORKING OR EVEN WON'T START AT HIGH AMBIENT TEMPERATURES.

The operating temperature range for Kvant laser projectors is +10°C (50°F) to +35°C (95°F). Using projectors in an environment with air temperatures within 35°C (95°F) to 45°C (113°F) is not harmful to the projector, but limits its ability to disperse the heat efficiently, resulting in lowered nominal power output or complete cutoff.

There is a risk of permanent damage to the laser projector if used in temperatures exceeding 45°C (113°F), in which case the warranty is voided.

Never place and use projectors near objects that generate excessive heat, such as radiators, powerful discharge lighting, or warm air outlets.

For the use in temperatures exceeding 35°C (95°F), installing the projector into the Monsoon box with a built-in AC unit is highly recommended. As a temporary solution, you can use a small AC unit and direct its output towards the projector's intake fans.

IS IT POSSIBLE TO DO MODIFICATIONS TO THE ELECTRONIC CIRCUITRY OF THE LASER PROJECTORS?

It is not allowed to modify the electronic circuitry of laser projectors without prior authorization and approval of Kvant's technical support representative. Any unauthorized modifications will result in immediate warranty termination. There is a risk of electric shock and the risk of injury or property damage by laser radiation. Unauthorized modifications of the circuitry may cause a change in the projector's functionality and specifications, making it non-compliant with regulations and standards of Class 4 laser devices.

WHAT IF I FEEL A SMALL ELECTRIC SHOCK WHEN TOUCHING THE METAL PARTS OF THE PROJECTOR'S HOUSING?

Turn off the projector immediately. Disconnect the projector from the AC mains power supply. A qualified electrician must check the mains power cable and the socket.

The two common reasons are:

1. Too long AC mains power cable with joined cables N (blue) and PE (yellow-green). The 3-wire connection is essential.
2. Disconnected, not connected, or interrupted PE wire in AC mains power cable or AC wall plug.

WHAT IF I FEEL A PRETTY STRONG ELECTRIC SHOCK WHEN TOUCHING THE METAL PARTS OF THE PROJECTOR'S HOUSING?

There is a danger of fatal electric shock! Turn off the projector immediately. Disconnect the projector from the AC mains power supply. A qualified electrician must check the mains power cable and the socket.

CAN ANYBODY OPERATE THE LASER PROJECTOR?

No. The laser projector should be operated by an adult person who passed their training as a Laser Display Operator of Class 4 laser devices. The operator should be aware of and follow all the regulations, requirements, and laws regarding a country where operating the Class 4 laser system.

The manufacturer holds no responsibility for injuries or damages caused by the use of this laser display equipment.

WHERE CAN I FIND THE CONFORMITY DECLARATION (CE) FOR THIS LASER PROJECTOR?

Conformity Declaration is part of the user manual. Because the corresponding standards are updated from time to time, please contact a distributor or one of our sales representatives to obtain the latest Conformity Declaration for your laser projector.

HOW CAN I ECOLOGICALLY DISCARD AN OLD LASER PROJECTOR?

Laser projector doesn't contain any poisonous materials or dangerous components. Therefore, you can ecologically discard it the same way you would do any old electronic equipment. For more details, please contact your local waste authority.

SAFETY FEATURES

COVER INTERLOCKS

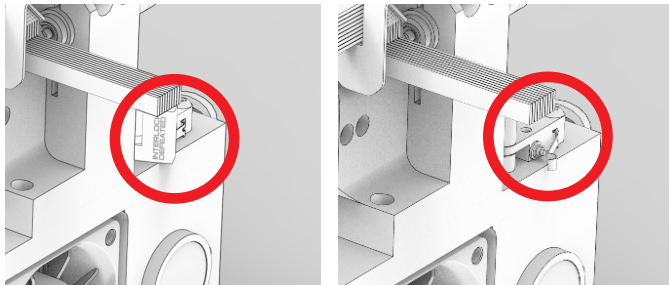

Interlock closed

Interlock open

BEAM SHUTTER

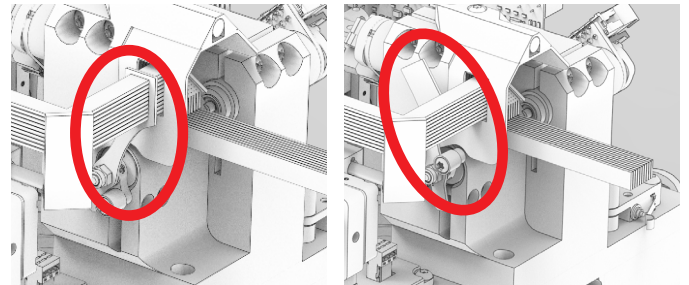

Shutter closed

Shutter open

STROBE LED



EMISSION LED



CONTACT INFORMATION

12



Address:

Kvant Lasers s.r.o.
Odborárska 23
831 02 Bratislava
Slovakia, Europe

E-mail: info@kvant.sk

Telephone: 00421-2-654 113 55

Technical support contact:

E-mail: micek@kvant.sk
Telephone: +421 918 339 980

Made in EU.

SOFTWARE



Address:

Pangolin Laser Systems, Inc.
1265 Upsala Road, suite 1165
Sanford, FL 32771

Technical support contact:

e-mail: support@pangolin.com
Telephone: +(407) 299-2088

DIMENSION DETAILS

Bottom view

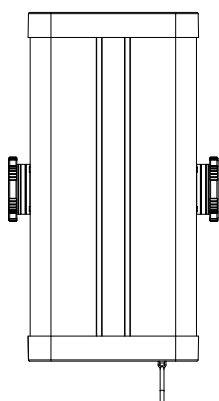

Front view

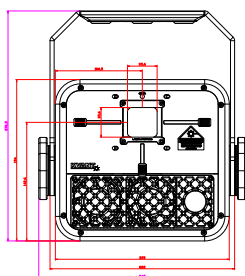

Side view

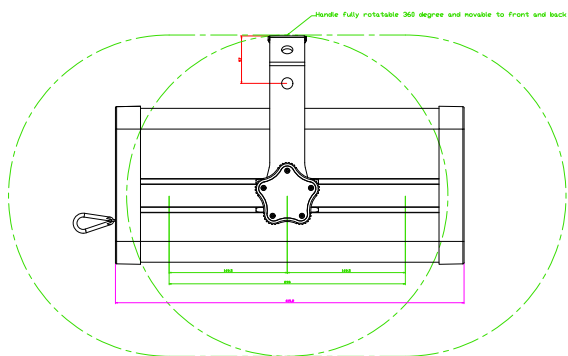

Back view

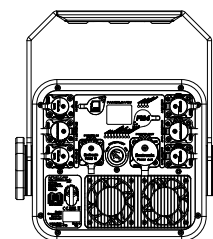

Top view

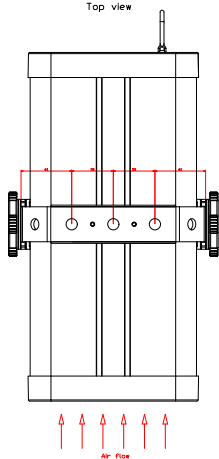

Overall dimensions of the laser projector are highlighted by purple
Airflow required for cooling: 180 cubic meter per hour